

# morbidelli m90

CNC machining centre for drilling and routing



**THE AFFORDABLE ALL-IN-ONE TECHNOLOGY**

**SMALL SIZE**

**MORBIDELLI M90**

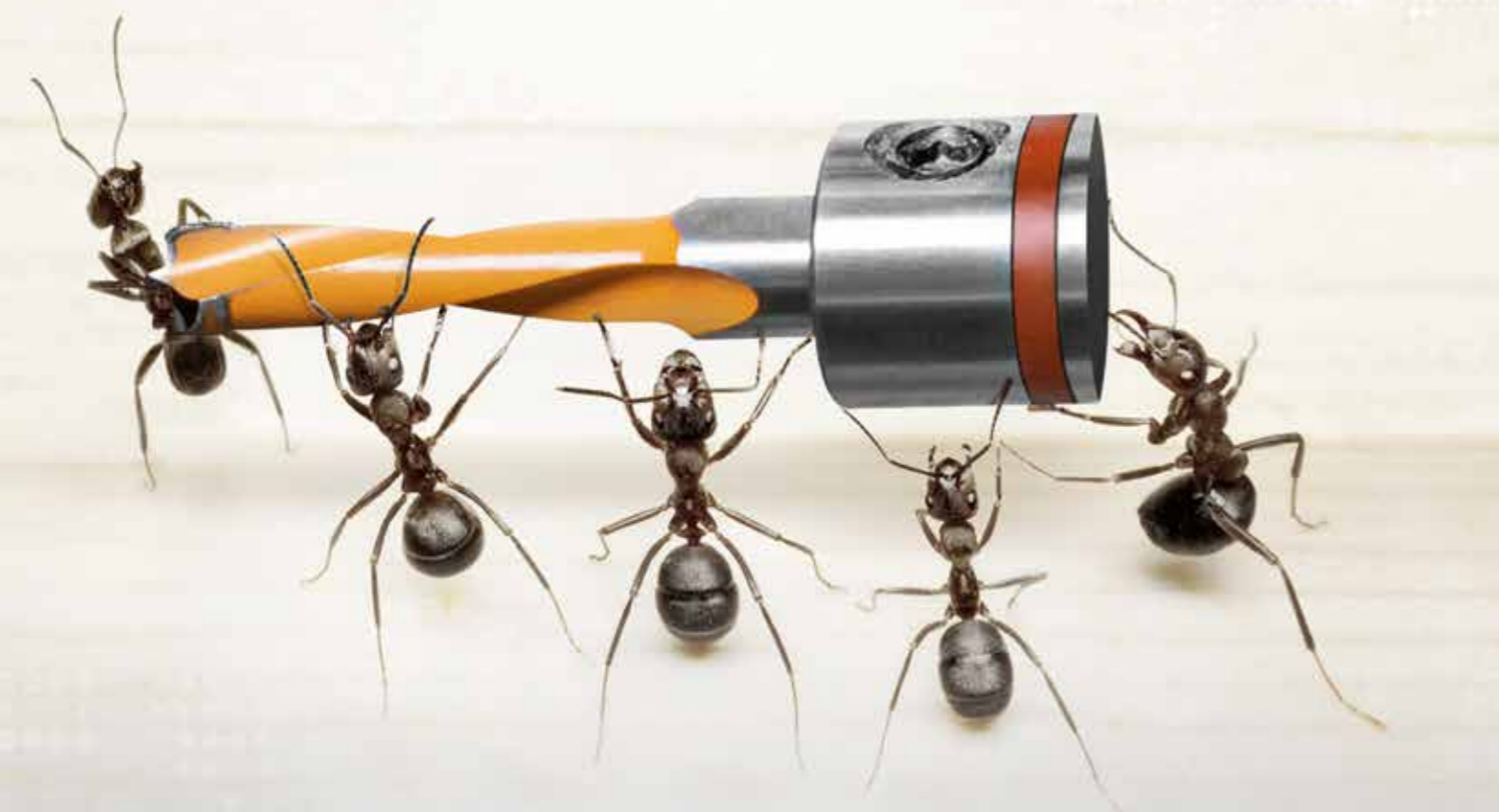

**GREAT PERFORMANCE**



**THE AFFORDABLE  
ALL-IN-ONE TECHNOLOGY**

## FREEDOM



**Optimizing the space** in your factory thanks to the PRO-SPACE solution without safety fences.

**Accessible and ergonomic 360° all around**, no floor obstructions: all the components are within the base.

**Total safety and freedom** to load large panels (as wide as 1600 mm) due to the work table being entirely accessible.

## TOP QUALITY



**Reduced maintenance**, thanks to the **RO.AX** (Rotoaxial spindle technology) drilling bits. It is recommended only after more than 1000 hours of work.

**60% of time saved on drilling cycles** with the new drill-bits designed to guarantee the best effectiveness on all types of material.

**Unrivalled finishing quality** with the 3/4-axis electrospindle up to 24000 r.p.m.

## FASTER



**Up to 25 tools** always available **on board**.

**Less than 15"** for the **tool change** with the 14 position **FAST** tool changer.

## FLEXIBLE



From panels to furniture, morbidelli m90 is **the right solution configured for all your needs** and your investment plan.

The **TV FLEX work table** allows for managing the quantity of vacuum pods you need on any rails, depending on the type of machining.

**No limits** for machining work pieces thick up to 180 mm on 75 mm vacuum pods.

## CLEAN



**No problem with dust or shavings** thanks to the intelligent solution of the dust collection box located in an ergonomic position.

**Free space on the floor** with the vacuum pump integrated in the machine base.

## DIGITAL



**CAD/CAM programming software** to design all the production process.

**Maestro cnc** allows easy, quick and errorless machine management.

20

**MAESTRO** Software

25

Technical data



# TECHNICAL FEATURES OVERVIEW

TECHNOLOGICAL ADVANTAGES

**morbidelli m90**  
CNC machining centre for drilling and routing



All at your fingertips thanks to the **TECPAD 7"** colour remote control with touch-screen.



Faster working cycles with the 14 position **FAST** tool changer.



- **Unrivalled finishing quality**, thanks to the 3/4-axis operating unit.
- **60% of time saved** on drilling cycles with the drill-bits designed to guarantee the best effectiveness on all types of material.
- **Reduced maintenance**, thanks to the **RO.AX** (Rotoaxial spindle technology) drilling bits. It is recommended only after more than 1000 hours of work.

Free access, having the cable-holder chain enclosed within the machine frame.



**TRB** tool changer with 11 positions.



Free space on the floor with the vacuum pump integrated in the machine base.

100% of the working area covered by all the units of the operating unit.



No problem with dust or shavings thanks to the intelligent solution of the dust collection box located in an ergonomic position.

The **TV FLEX** work table allows for managing the quantity of vacuum pods you need on any rails, depending on the type of machining.

Intuitiveness and easiness with the **APPS** included in the Maestro software for the production of furniture and furnishing elements.

# MINIMUM OVERALL DIMENSIONS MAXIMUM SAFETY AND FLEXIBILITY



## “PRO-SPACE” PROTECTIONS

Loading zone completely free to reduce the space occupied to the minimum.

The absence of perimeter protections facilitates the work table access on all the sides of the machine.

## OVERALL DIMENSIONS

### MORBIDELLI M90

		Height	Width	Length
Working area 3115 x 1320	mm	2710	2965 (3965*)	5880 (5945*)

\*It includes the operating area

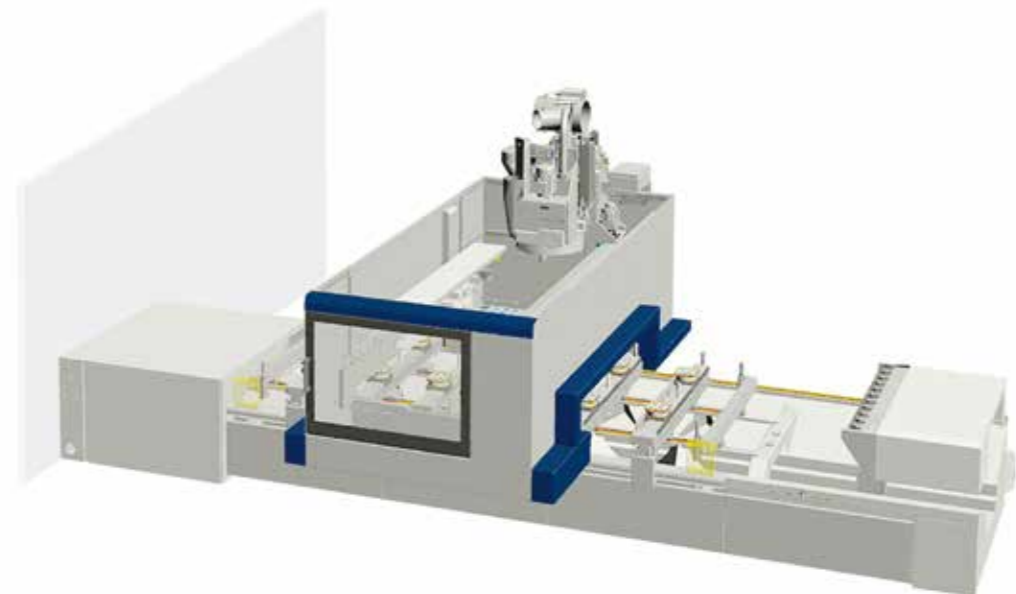



# MACHINING UNIT: DRILLING UNIT

The higher drilling capacity in its category up to 21 vertical spindles, 10 horizontal spindles and an integrated blade.

## INDESTRUCTIBLE AND WITH LOW MAINTENANCE

The sturdiness of drilling heads is proven by the reduced maintenance costs: it is recommended only after more than 1000 hours of work.

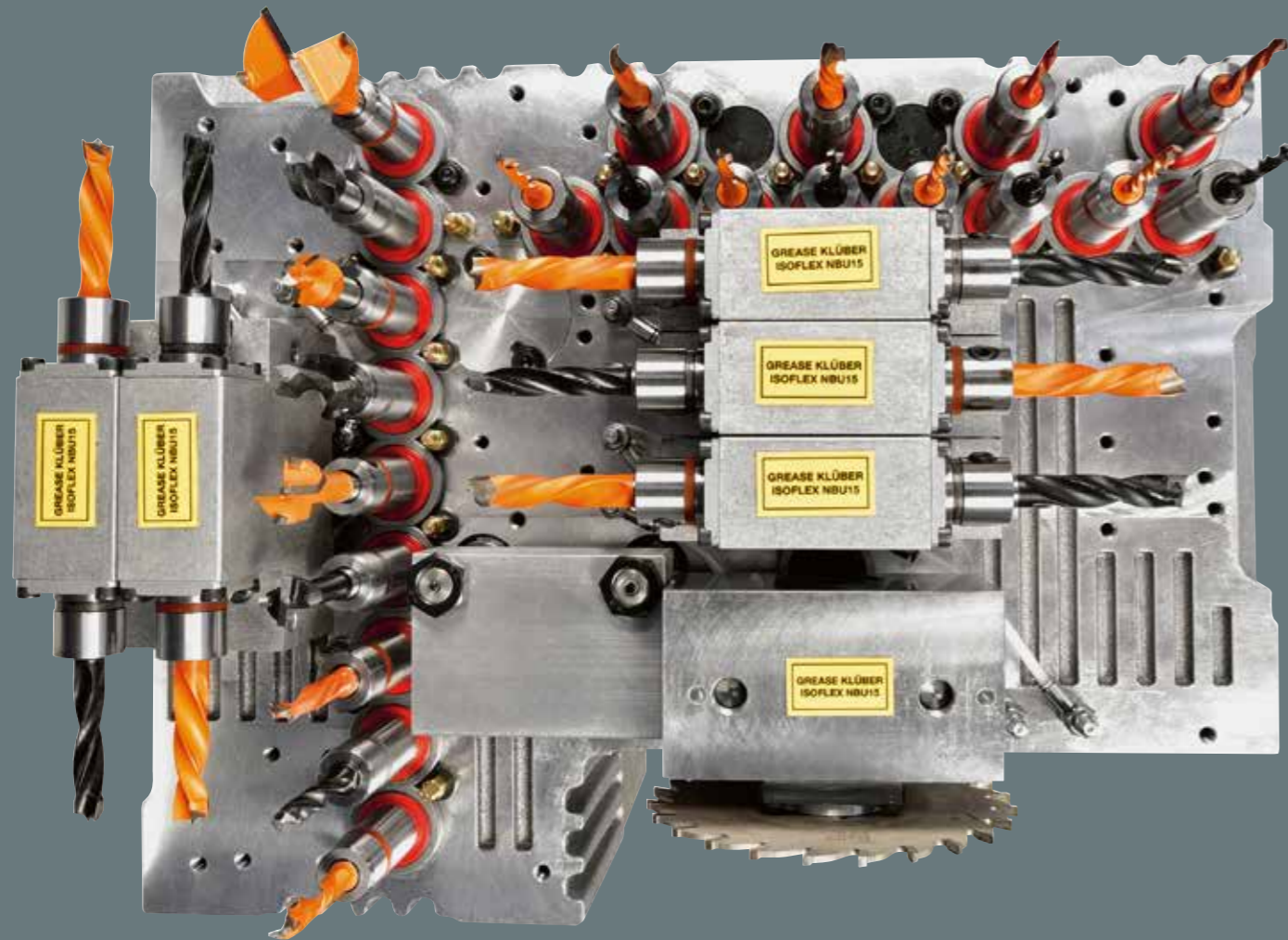

**morbidelli m90**  
CNC machining centre for drilling and routing

60% of time saved on drilling cycles with the new drill-bits designed to guarantee the best effectiveness on all types of material.





# THE PERFECT DRILLING



**High performance drilling units thanks to the spindles with innovative design.** The new drilling spindle offers optimal solutions to achieve the highest quality of finishing and the maximum speed of the whole execution.



## RO.AX. SPINDLE

No backlash during machining with the new RO.AX technology (Rotoaxial spindle technology), the most efficient spindle on the market with rotation speeds up to 8000 rpm.

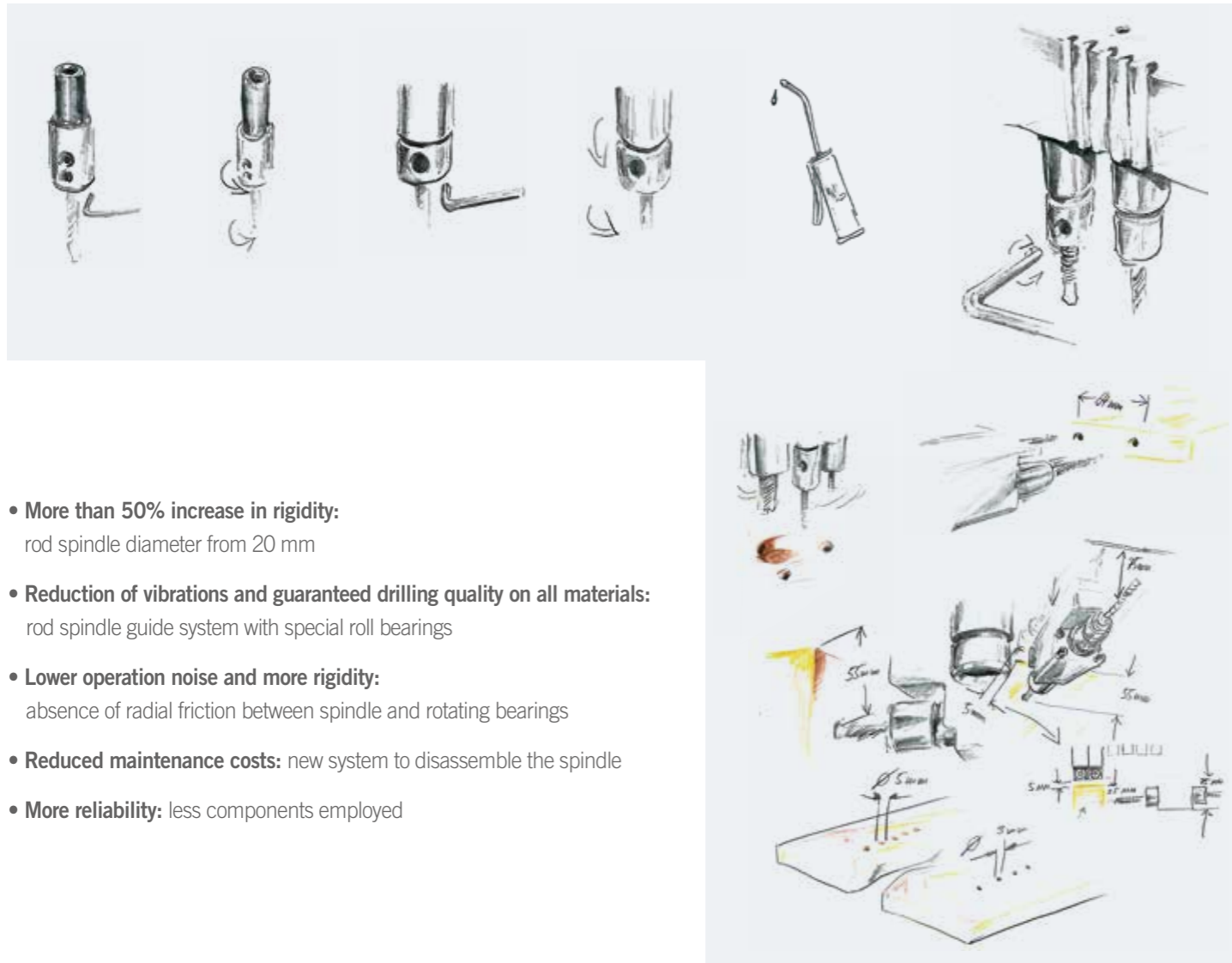

- **More than 50% increase in rigidity:**  
rod spindle diameter from 20 mm
- **Reduction of vibrations and guaranteed drilling quality on all materials:**  
rod spindle guide system with special roll bearings
- **Lower operation noise and more rigidity:**  
absence of radial friction between spindle and rotating bearings
- **Reduced maintenance costs:** new system to disassemble the spindle
- **More reliability:** less components employed





**morbidelli m90**  
CNC machining centre for drilling and routing

## MACHINING UNIT: ROUTING UNIT

UNRIVALLED FINISHING QUALITY with the 3/4-axis electrospindle up to 24.000 rpm.



## ALL AT YOUR SPINDLE FINGERTIPS! UP TO 25 TOOLS ALWAYS AVAILABLE ON BOARD

No idle time for the tool change from a machining process to another one with the 14-position **FAST** tool changer.

*TRB side tool changer with 11 positions.*





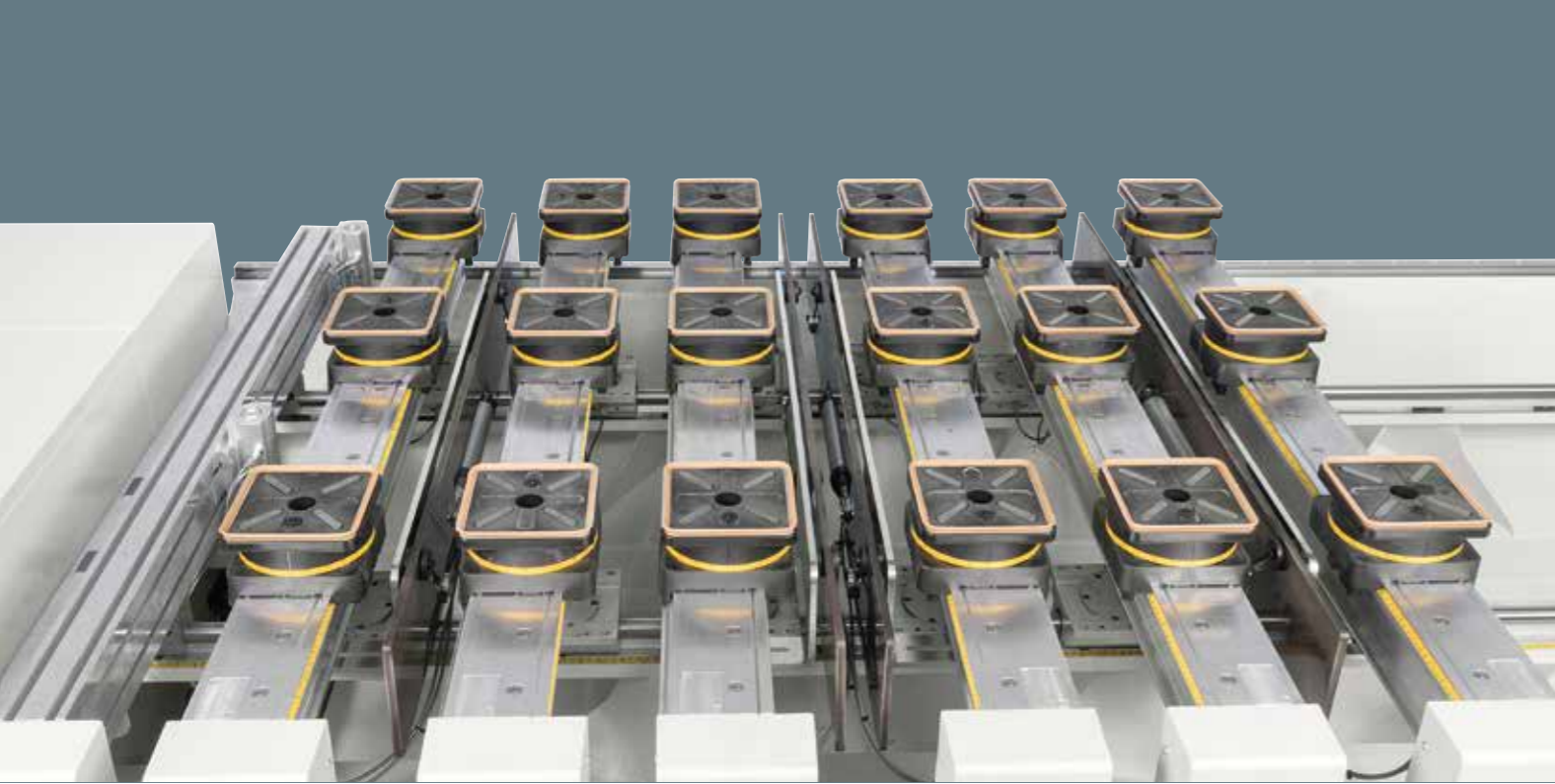

## TOTAL VERSATILITY: RAILS WORK TABLE

The **TV FLEX** work table allows for managing the quantity of vacuum pods you need on any rails, depending on machining requirements.

*Comfortable pushbutton to have at your fingertips all the necessary commands for the programs execution.*



*Easy positioning of heavy work pieces and large panels with the lifting support.*

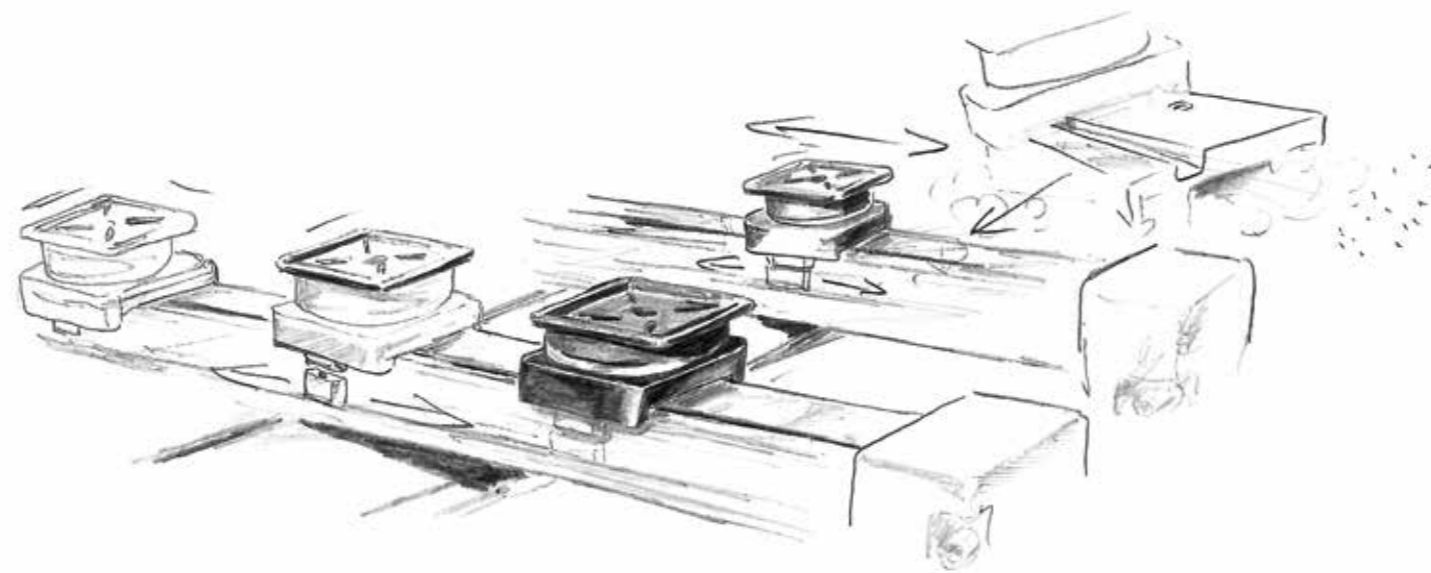
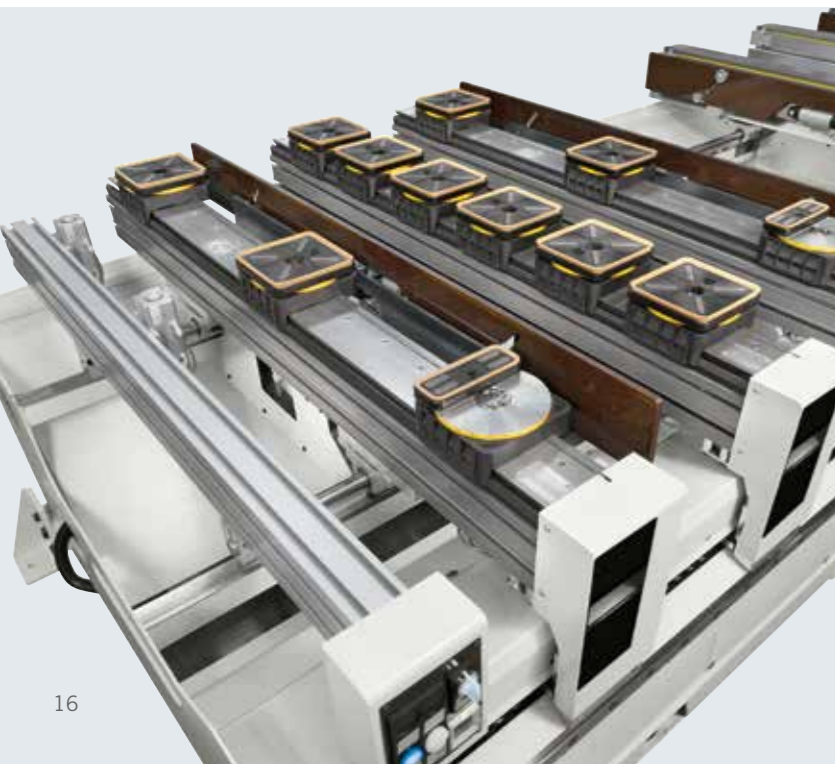

*It is possible to add or remove vacuum pods or clamps with a simple movement of the hand.*



# SPACE? NO PROBLEM!

**morbidelli m90**  
CNC machining centre for drilling and routing

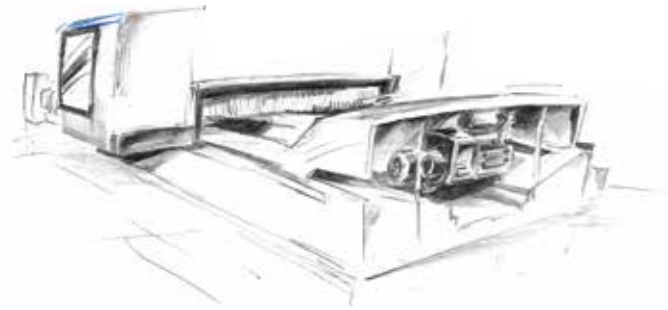

*Free access without obstacles on the floor, cable-holder chain and vacuum pump integrated in the machine base.*



*Rapidity and ergonomics to equip and do maintenance to the operating group thanks to the practical frontal opening.*

*No problem with dust or shavings thanks to the dust shavings conveyor belt equipped with an extraction outlet and the dust collection box located in an ergonomic position.*





# M Maestro Digital Systems

SMART SOFTWARE AND DIGITAL SERVICES TO ENHANCE PRODUCTIVITY OF WOODWORKING AND FURNITURE INDUSTRIES.

SCM accompanies woodworking companies throughout their whole process combining machines with matching software solutions and digital services, with a constant strive to enhance company productivity.

The software solutions powered by SCM are developed to optimize machine usage as well as the entire process, providing integration with the different software existing in the company.

design > programming and data generation

Maestro office

Office

Factory

Maestro active

cutting > routing drilling

## SOFTWARE

Simple, smart and open Maestro software are tailored on the machine technology as well as on the entire process. All Maestro software share a common mission:

**easy to use**, so that any operator can easily and confidently learn and use the software

**smart**, with algorithms and computing modules aiming at the best possible result

**open in order to integrate** existing software, and provide customer the coverage of all his process.

## DIGITAL SERVICES

Transforming the way, it delivers services to its customers through digital technologies and particularly, the IoT platform that collects and analyses data coming from the machine, **SCM created a world of services enabled by Maestro connect**.

Meaning that connecting an SCM machine through Maestro connect will let customer subscribe a program of fast-evolving services and access a wide range of benefits that even go beyond the machine experience and will support and assist you through the whole life-cycle of your machine.

### Maestro connect IoT Platform

1 Machine monitoring, KPIs, early warning

2 Maintenance equipment

3 Predictive maintenance

4 Report and historical data export to MES

5 Warranty extension

6 Augmented remote support

7 Smart learning, SELF-HEALING, video tutorials

8 Asset management with e-shop SCM Spare Parts







## Maestro cnc

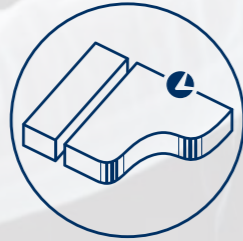

In the office, before the production, the design and programming system Maestro cnc ensures that routing, drilling or sawing can quickly and easily be programmed thanks to 3D graphics of work pieces and machining and clamping aids as well as a smart App and macros library to program any machine operation with a mouse click. Another click away and CNC programs are automatically generated.

### SOFTWARE

Office



## Maestro active cnc

Maestro active is the new operator interface software which has been unified across all SCM technologies. A single operator can easily and confidently run multiple machines due to controller and interface consistency: regardless the machine, Maestro active maintains the same look&feel, with many identical icons and navigation buttons, thus ensuring the same approach to interaction.

### EASE OF USE

The new interface has been specifically designed and optimized for immediate use via touch screen. Graphics have been redesigned for simple and comfortable navigation, with tablet-like icons on touch screen controller.

### ZERO ERRORS

Improved productivity thanks to integrated help and recovery procedures that reduce the possibility of error from the operator's side.

### SOFTWARE

Factory

## Maestro cnc

### THE SOFTWARE THAT SIMPLIFIES THE WORK

CAD/CAM programming software to design all the production processes. Developed in Windows® environment it ensures easy programming with an advanced, simple and intuitive sketching environment that features all the tools necessary to design the parts, their layout on the work table, tools management and the relative machining operations. All the procedures are contained in a perfectly integrated and high performance software.

#### ADDITIONAL FUNCTIONS



#### Maestro pro view - Unique 3D display

3D Simulator that allows users access to a three dimensional model of their machine in their office and view the operations that will be carried out during the production in advance on their PC.



#### Maestro apps - Unique know-how

Maestro apps is a library of programming functions that are always available and easy to use, developed by SCM for the production of parts for doors, windows, stairs, furniture and furnishings.



#### Maestro msl connector - Total integration

Connector for third-parties with design software.

#### SPECIALISED MACHINING



#### Maestro cabinet - Unique in the creation of furniture

This application is designed for the home and office furniture sector to design furniture and program cabinet production step by step.



#### Maestro label - Unique labeling process

Integrated module to manage label's models, which develops labels by inserting texts, images, parameters and the main barcode formats.

## Maestro active cnc

### A REVOLUTIONARY APPROACH TO INTERACT WITH YOUR SCM MACHINE

#### FULL CONTROL OF PRODUCTION PERFORMANCES

The creation of customizable reports by operator, shift, program, forecast period (and much more) allows to monitor, optimize and improve the production performance.

#### FULL MACHINE AWARENESS AND KNOWLEDGE MANAGEMENT SYSTEM

Maestro active allows to record the times related to setup, maintenance, training and other events, tracing all the activities in a database. The operator's know-how is also stored and made available to other people inside the organization thanks to the possibility to comment and document all production events or notifications.

#### ORGANIZE YOUR PRODUCTION

Maestro active allows to create different users with different roles and authorizations (e.g.: operator, maintainer, administrator, ...). Any user can only execute the functions whose permissions have been assigned to him. It is also possible to define the work shifts on the machine and then detect activities, productivity and events that occurred in each shift.

#### TOTAL QUALITY OF THE FINISHED PRODUCT

With Maestro active the quality of the finished piece is no longer put at risk by worn tools. The new Maestro Active Tool Life Determination system sends notification messages as the tool reaches its end of life and recommends its replacement at the most appropriate time.

#### TOOLS? NO PROBLEM!

Maestro active guides the operator during the magazine tooling phase, taking into account the programs to be executed.



# A WORLD OF SERVICES FOR GREATER EFFICIENCY

## Maestro connect

### CONNECT YOUR MACHINE AND GAIN ACCESS TO A WORLD OF SERVICES

Connecting your machine through Maestro connect will let you subscribe a program of fast evolving services. You will access a wide range of benefits that even go beyond the machine experience and will support and assist you through the whole life-cycle of your machine.

### FASTER SERVICE INTERVENTION AND PROBLEM RESOLUTION

Maestro connect provides real time data and Health Records of the Machine also to SCM Service drastically reducing its troubleshooting time.

### WORKING ALWAYS IN PERFECT CONDITIONS

Maestro Connect can provide a full kit of sophisticated sensor devices to detect and warn the operator in case of alarming conditions of the machine.

## DIGITAL SERVICES

### SMART MAINTENANCE: DOWN TIME REDUCTION

Maestro connect reduces maintenance downtime thanks to:

- Automatic maintenance notifications and scheduling, to prevent failures and work in the best conditions of use
- Direct connection to SCM Service thanks to an automatic ticket opening function

### SMART MACHINE: ANYTIME, ANYWHERE AWARENESS

Connecting your SCM machine also means having your machine always at hand. Immediate instant notifications in case of alarms or downtimes allow customers to immediately take an action thus optimizing his productivity.

### SMART MANAGEMENT: PRODUCTION PERFORMANCE OPTIMIZATION

Reports and KPIs allow further analysis thus increasing Customer Knowledge about his performance and results.

### SMART PARTS: FAST PARTS REPLENISHMENT

Repairs are scheduled proactively since the system provides Spare Parts suggestions and a direct Integration with Smart Parts e-shop.

### SMART LEARNING: EXECUTE WORK AND RECEIVE PROBLEM SOLVING SUPPORT

Maestro connect provides an intuitive Problem Solving Management System to help the operator to self solve any issue.

### SMARTTECH: FASTER AUGMENTED SUPPORT

Maestro connect allows augmented reality support by means of Smarttech: the head-wearable computers with wireless connectivity that will bring the interaction between customer and SCM service to a higher level.

### SMART WARRANTY: YOUR MACHINE ALWAYS IN PERFECT CONDITIONS

Together with scheduled maintenance contracts, you can take care of your asset by doubling the warranty from 1 year to 2 years\* for complete peace of mind!

\*please read the complete contract to understand terms and conditions.

## TECHNICAL DATA

### AXES

Vectorial speed X-Y axes	m/min	56
Z axis panel clearance	mm	180

### DRILLING UNIT

Independent vertical spindles (up to)	no.	21
Independent horizontal spindles (up to)	no.	10
Rotation speed (up to)	rpm	8000
Integrated blade in X, diameter	mm	125

### ROUTING UNIT

Motor power (up to)	kW (hp)	14 (19)
Rotation speed (up to)	rpm	24000
Available tools on tool changer (up to)	positions	25

### INSTALLATION

Dust extraction air consumption	m <sup>3</sup> /h	4430
Dust extraction air speed	m/sec	25
Dust extraction outlet diameter	mm	250



## THE USE OF POWER ONLY WHEN IT IS REQUIRED

**SavEnergy** allows making things operate only when they are really necessary. It means the machine automatically enters "stand-by" mode when there are no panels to be machined.

**COMPANY WITH  
QUALITY SYSTEM  
CERTIFIED BY DNV GL  
ISO 9001**

*The technical data can vary according to the requested machine composition. In this catalogue, machines are shown with options. The company reserves the right to modify technical specifications without prior notice; the modifications do not influence the safety foreseen by the CE Norms.*

*Maximum noise levels measured according to the operating conditions established by EN 848-3:2012  
Acoustic pressure in process (routing) 81 dbA (measured according to EN ISO 11202:2010, uncertainty K = 4 dB)  
Acoustic power in process (routing) 98 dbA measured according to EN ISO 3746:2010, uncertainty K = 4 dB)*

*Even if there is a correlation between above mentioned "conventional" noise emission values and average levels of personal exposure over eight hours of operators, these last also depend on the real operating conditions, duration of exposure, acoustic conditions of the working environment and presence of further noise sources, this means the number of machines and other adjacent processes.*



# PROMPT AND EXPERT TECHNICAL SUPPORT THROUGH A NETWORK OF 1000 TECHNICIANS AND AN INVENTORY OF 36,000 SPARE PARTS.

HIGHLY SPECIALISED TECHNICIANS, EFFICIENT MANAGEMENT AND 6 SPARE PARTS BRANCHES AROUND THE WORLD GUARANTEE A CLOSE, SAFE AND EFFECTIVE TECHNICAL SUPPORT.

## SERVICE

SCM provides a service that goes beyond the purchase, to guarantee the long term performance of your technological production system and peace of mind for your business.

### A COMPLETE RANGE OF AFTER-SALES SERVICES

- installation and start-up of machines, cells, lines and systems
- tailored training programs
- telephone support to reduce times and costs when machines are not working
- preventive maintenance programs to guarantee long term performance
- complete renovation of machines and plants to renew the added value of the investments
- custom upgrading to update machines and plants and meet new production requirements

## SPARE PARTS

SCM Group can count on 140 spare parts professionals worldwide to meet any request with real time shipments.



### 36,000 SPARE PARTS

Our spare parts inventory, with a value of 12 million euros, covers every single machine



### SPARE PARTS GUARANTEED

We guarantee also hard to find parts, with 3,5 million euros invested in "critical" spare parts.



### IMMEDIATE AVAILABILITY

Over 90% of orders received are carried out the same day thanks to the huge inventory available.



### 6 BRANCHES AROUND THE WORLD

The spare parts service can count on worldwide support (Rimini, Singapore, Shenzhen, Moscow, Atlanta, São Bento do Sul)



### 500 SHIPMENTS A DAY

# THE STRONGEST WOOD TECHNOLOGIES ARE IN OUR DNA

## SCM. A HERITAGE OF SKILLS IN A UNIQUE BRAND

Over 65 years of success gives SCM the centre stage in woodworking technology. This heritage results from bringing together the best know-how in machining and systems for wood-based manufacturing. SCM is present all over the world, brought to you by the widest distribution network in the industry.

65+ years history

3 main production sites in Italy

300.000 square metres of production space

20.000 machines manufactured per year

90% export

20 foreign branches

400 agents and dealers

500 support technicians

500 registered patents

In SCM's DNA also strength and solidity of a great Group. The SCM Group is a world leader, manufacturing industrial equipment and components for machining the widest range of materials.

## SCM GROUP, A HIGHLY SKILLED TEAM EXPERT IN INDUSTRIAL MACHINES AND COMPONENTS

### INDUSTRIAL MACHINERY

Stand-alone machines, integrated systems and services dedicated to processing a wide range of materials.



WOODWORKING TECHNOLOGIES



TECHNOLOGIES FOR PROCESSING COMPOSITE MATERIALS, ALUMINIUM, PLASTIC, GLASS, STONE, METAL

### INDUSTRIAL COMPONENTS

Technological components for the Group's machines and systems, for those of third-parties and the machinery industry.



SPINDLES AND TECHNOLOGICAL COMPONENTS



ELECTRIC PANELS



METALWORK



CAST IRON







**SCM GROUP SPA**

via Casale 450 - 47826 Villa Verucchio, Rimini - Italy  
tel. +39 0541 674111 - fax +39 0541 674274  
morbidelli@scmgroup.com  
www.scmwood.com