

# windor nt1

angular machining centre for windows and doors

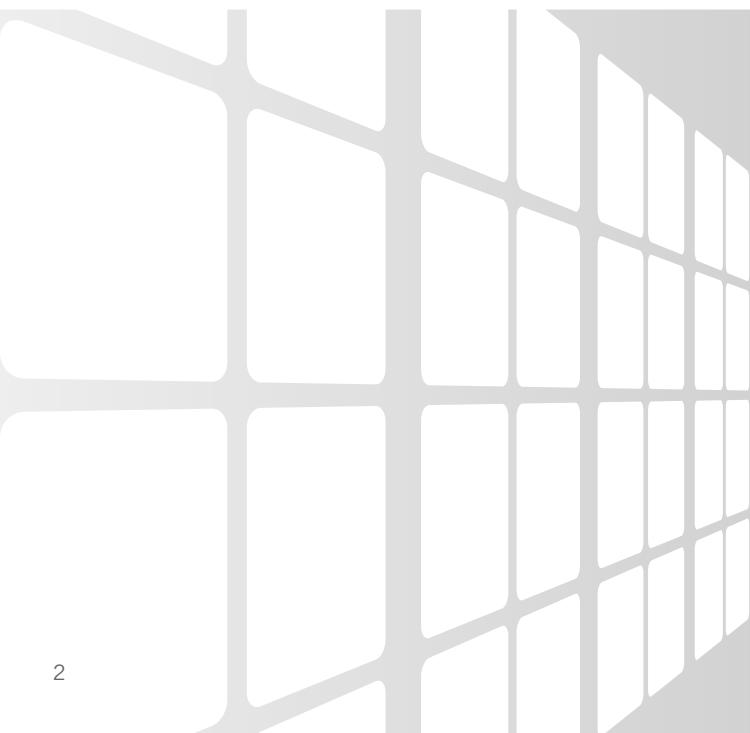

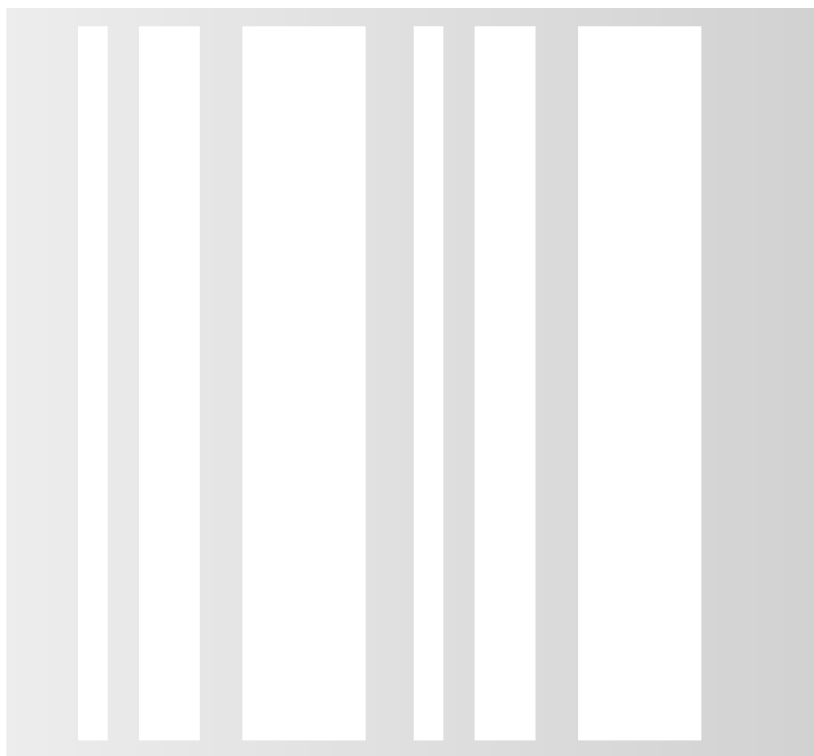
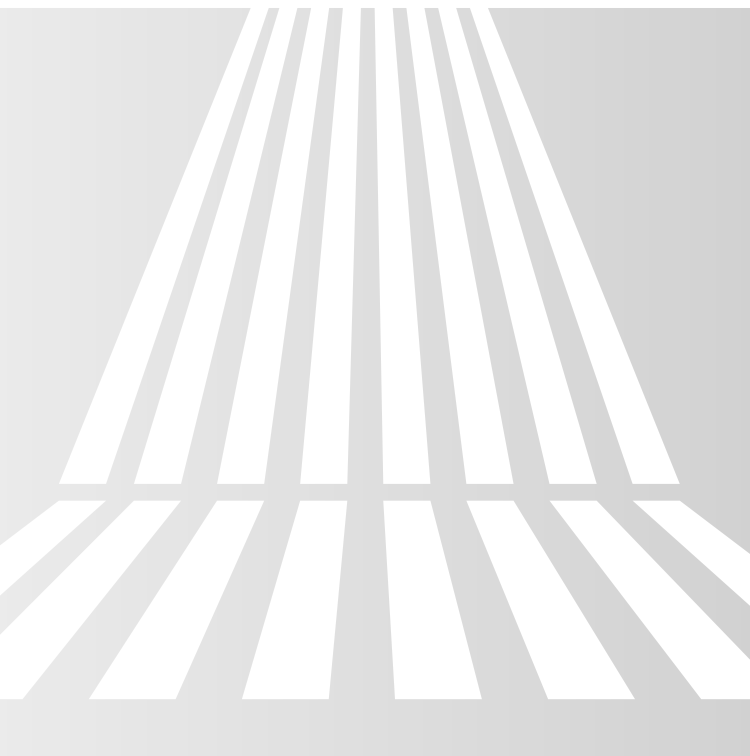

# THE MORE FLEXIBLE AND ECONOMIC SOLUTION FOR WINDOW FRAME MANUFACTURING



## QUALITY



### **Best-in-class performance**

Production of all types of tenon, straight and angled.  
Excellent precision during the processing thanks to the solid structure of the tenoning carriage.

## EFFICIENCY



### **Increased productivity**

No limits to profile execution: to meet all the profiling requirements, the machine can be fitted with two 50x320 mm spindles.

## VERSATILITY



### **Maximum flexibility**

The drilling-routing unit allows to perform all the complementary machining: the machined work-pieces are ready to be assembled.

## STRENGTH



### Reliable technology

High performance and quick set-up: the machine can be equipped with “HSK” interchangeable spindles in both the tenoning and the profiling units.

## PRECISION



### Complete process

Possibility of storm proofing operation in a simple way, always ensuring an optimal finish quality.

## RELIABILITY



### Ergonomic

Completely enclosed machine in order to reduce noise to a minimum and ensure maximum safety for the operator.

# windor nt 1

## TECHNICAL FEATURES OVERVIEW

TECHNOLOGICAL ADVANTAGES



**Profiling unit**  
*Increased productivity.*



**Console eye-M**  
*Ease of use.*



**Storm proofing**  
*Complete process.*

**Machine structure**  
*Ergonomic.*

# windor nt1

angular machining centre for windows and doors



**Tenoning unit**  
*Best-in-class performance.*



**Drilling-routing unit**  
*Maximum flexibility.*

# TENONING UNIT



Production of all types of tenon, straight and angled.

Excellent precision during the processing thanks to the solid structure of the tenoning carriage anchored to the machine bed through prismatic guideways and moved by recirculating ball screws and Brushless motors.







Execution of angled tenons by interpolation: the same solution used in high-level machines but with a reduced investment and provided as standard configuration.



## "JOLLY" ANTI-SPLINTERING DEVICE

The automatic device prevents splintering. It can be easily removed during the tool change operations so the work changes are fast, precise and safe.



## WORK-PIECE AUTOMATIC ROTATION

Tenoning has never been so fast: due to the rotary movement of the presser, it is possible to process, in sequence, the two sides of the work-piece in a completely automatic way.

(option)

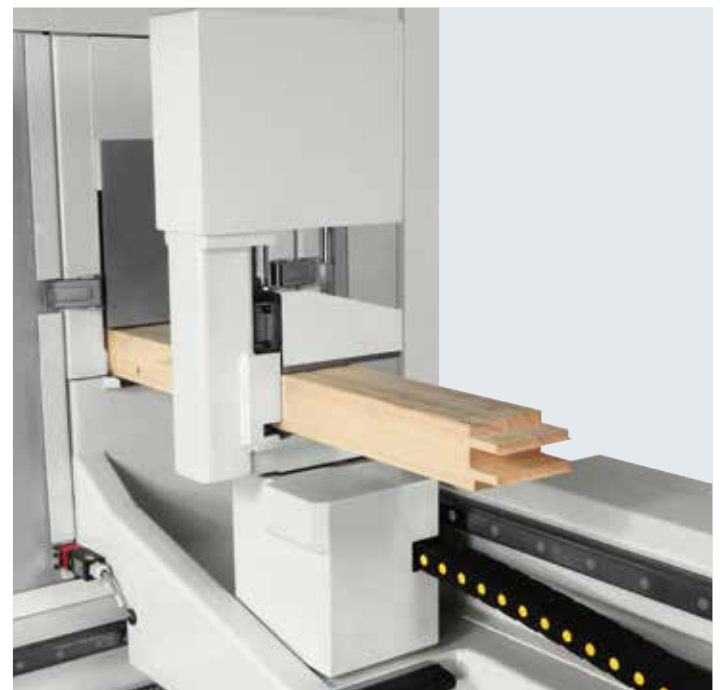

The clamping is achieved through a central presser with electronic positioning depending upon the work-piece length. The clamp ensures easy and safe locking even when components are loaded in pairs.

# DRILLING-ROUTING UNIT



## "OPTIMA 1" UNIT

Maximum flexibility with the possibility of providing a drilling-routing unit for all the complementary machining when tenoning: the machined work-pieces are ready to be assembled.



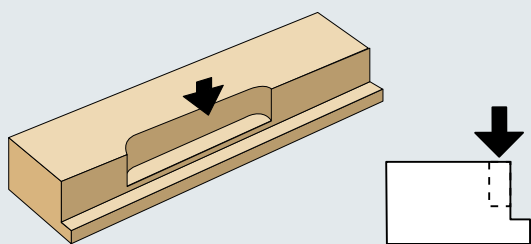

Spindle for glazing bead cut-off and hinges grooving

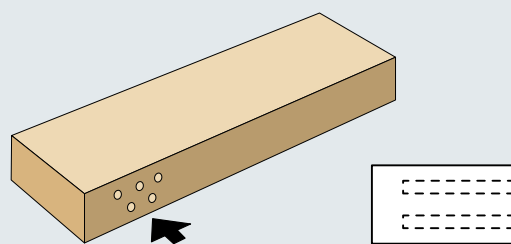

Unit for top and lengthwise drilling (1 hole at a time)

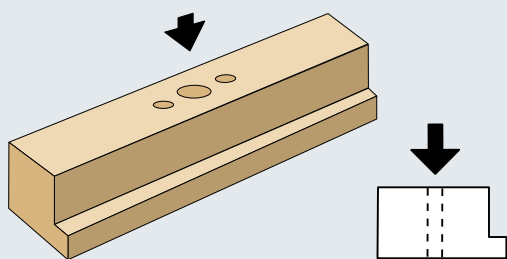

Unit for handle drilling (21,5 mm centre distance)

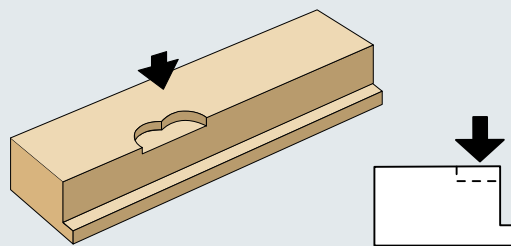

Unit for "tilt and turn" drilling

# PROFILING UNIT



No limits to profile execution: to meet all the profiling requirements, the machine can be fitted with two 50x320 mm spindles with 5-position pneumatic horizontal adjustment. It is possible to install tools with min.-max. diameter: 130-240 mm.



Feed system made of rubber rollers with reduced centre distance enabling the processing of even the shortest of elements.



## "DUO" MACHINING UNIT

Device for glazing bead recovery and hardware grooving, in one unit.

The pneumatic angular rotation in two positions 0-90° allows the fast changeover from a machining to another.

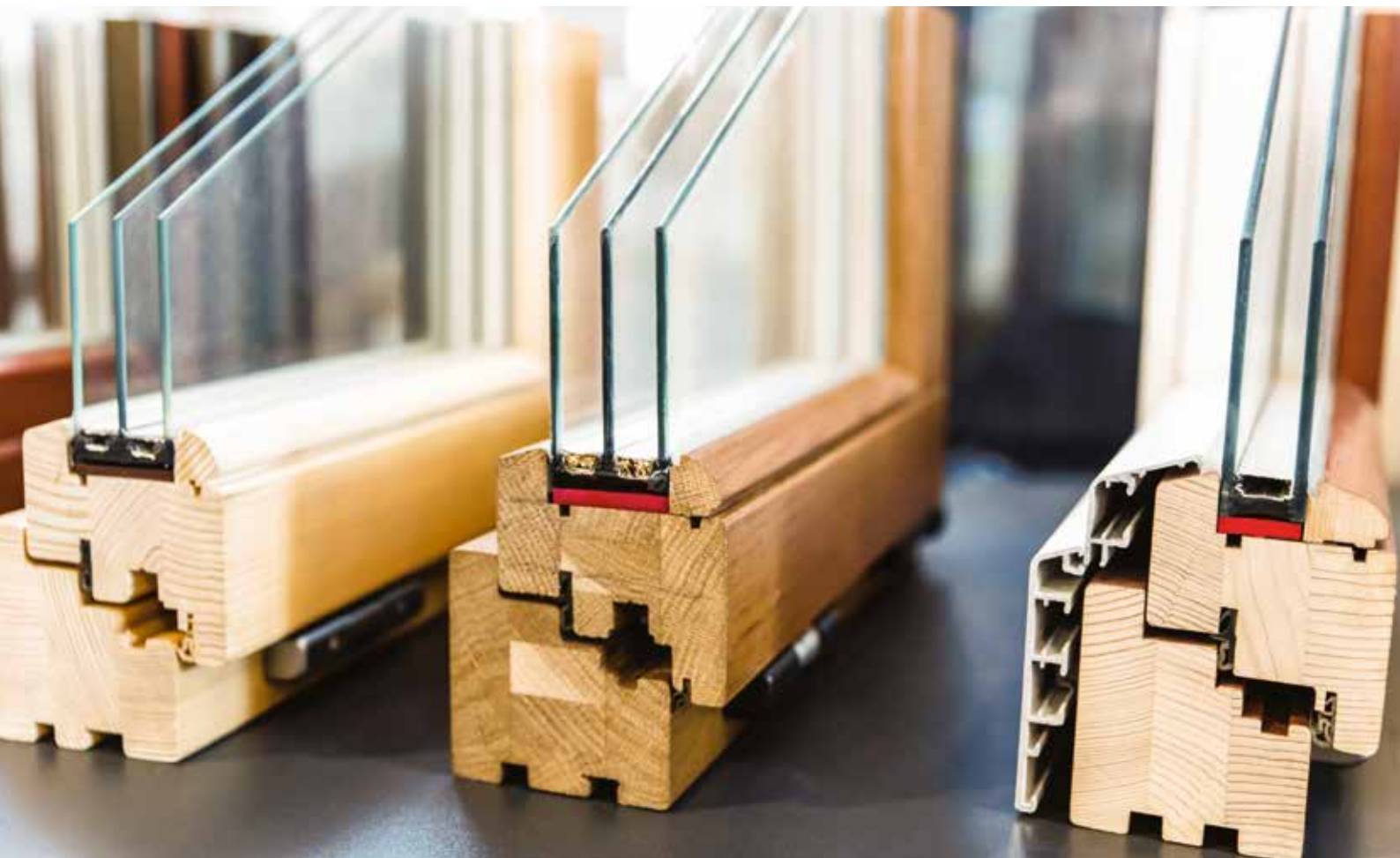

# OPTIONAL DEVICES



Horizontal unit for the machining of the bottom side of the work-piece.



Possibility of storm proofing operation in a simple way, always ensuring an optimal finish quality.



No idle time with the work-pieces return system, located at the end of the machine.

**SPINDLES WITH "HSK" TOOL CHUCK**

High performance and quick set-up: the machine can be equipped with "HSK" interchangeable spindles in both the tenoning and the profiling units.



For spindles with "HSK" tool chuck, a manual device for the tool change enables the operator to work in easy way and safe conditions.



**Console eye-M: smart, fair, interactive, effortless, revolutionary**

SCM innovative touch screen console eye-M allows a comfortable easy navigation of the machine managing software, Next, with a simple and intuitive interface, SCM supervisor for programming windows and doors elements but also for the interaction with data from external software house.

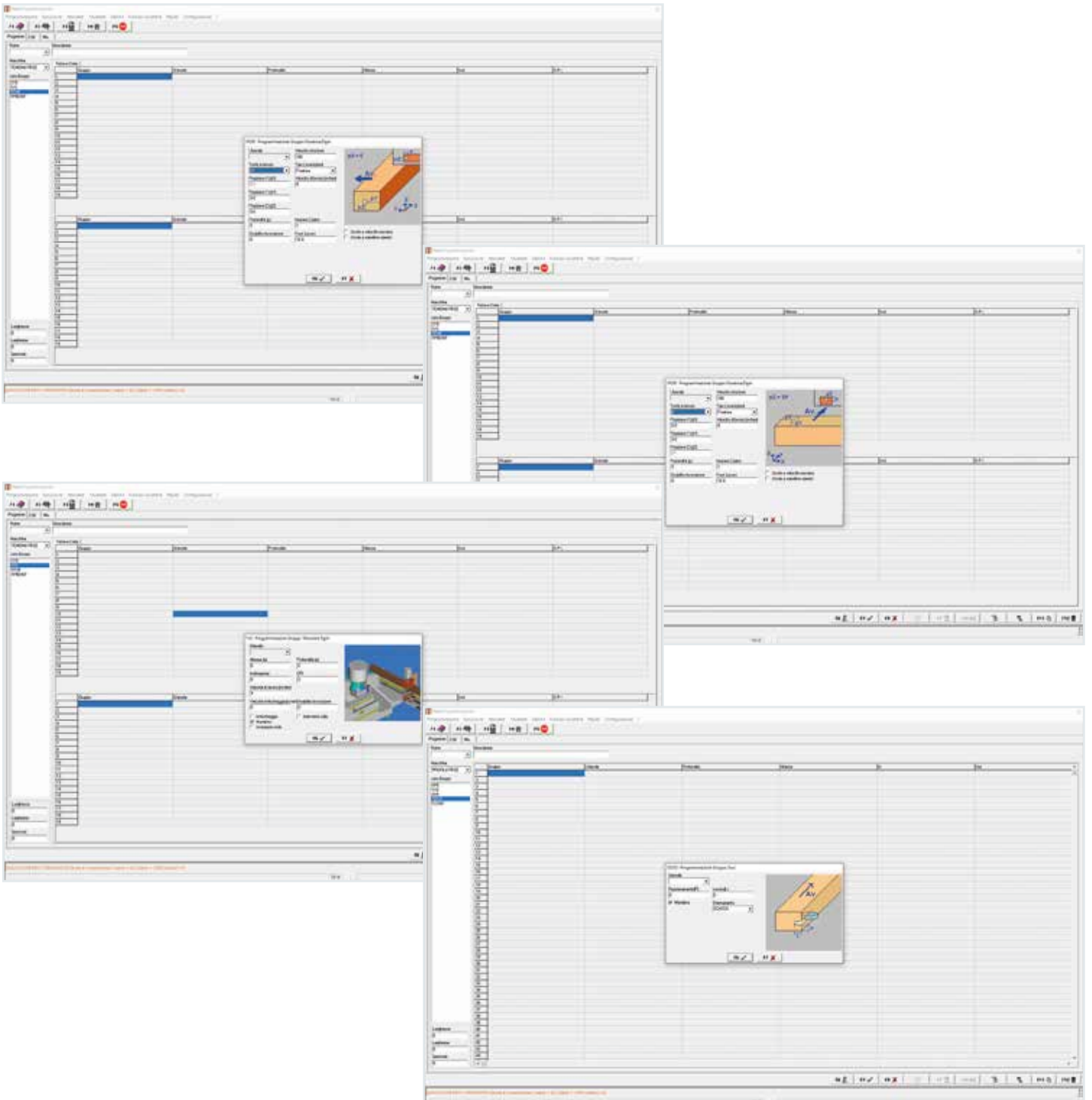



## WINDOR NT1

Min. - max. work-piece length	mm	200 - 3000 (200 - 3800 opt.)
Min. - max. work-piece width	mm	40 - 200
Min. - max. work-piece thickness	mm	40 - 140
Maximum tenon angle		± 60°
Feed speed of tenoning carriage	m/min	0 ÷ 12
Feed speed in profiling	m/min	6 (4 ÷ 10 opt.)
Worktable height in tenoning	mm	990
Worktable height in profiling	mm	870

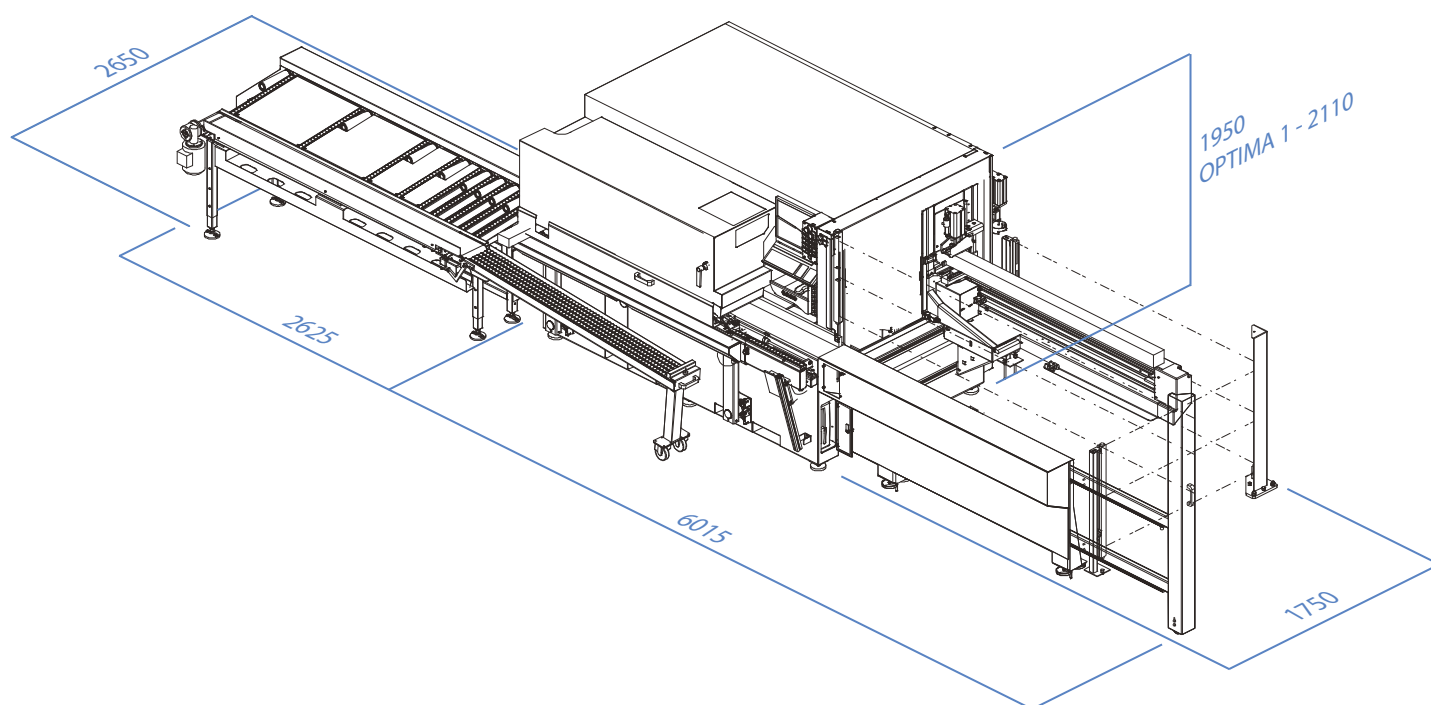

**COMPANY WITH  
QUALITY SYSTEM  
CERTIFIED BY DNV  
= ISO 9001 =**

*The technical data can vary according to the requested machine composition. In this catalogue, machines are shown with options. The company reserves the right to modify technical specifications without prior notice; the modifications do not influence the safety foreseen by the CE Norms.*

*Maximum noise levels measured according to the operating conditions established by ISO 7960 - 1995 / H.  
Acoustic pressure in process 90 dB(A) (measured according to EN ISO 11202:1995, uncertainty K = 5 dB).  
Acoustic power in process 100 dB(A) (measured according to EN ISO 3746: 1995, uncertainty K = 4 dB).*





*Even if there is a correlation between above mentioned "conventional" noise emission values and average levels of personal exposure over eight hours of operators, these last also depend on the real operating conditions, duration of exposure, acoustic conditions of the working environment and presence of further noise sources, this means the number of machines and other adjacent processes.*

# WE'LL GO THE EXTRA MILE FOR YOU



SCM OFFERS A FULL RANGE OF **HIGHLY SPECIALISED SERVICES** WITH A QUALITY AND RELIABILITY THAT STEM FROM 70 YEARS OF EXPERIENCE IN THE INDUSTRY.

From installation and production start-up to services and maintenance. From training to the supply of specific original spare parts: **we provide solutions designed around you!**

 <p><b>SERVICE AND MAINTENANCE</b></p> <ul style="list-style-type: none"> <li>• Remote support</li> <li>• Scheduled maintenance contracts</li> <li>• Warranty extension</li> </ul>	 <p><b>TRAINING SERVICE</b></p> <ul style="list-style-type: none"> <li>• Courses for machine operators</li> <li>• Software and programming courses</li> <li>• Training in production start-up</li> </ul>
 <p><b>SPARE PARTS</b></p> <ul style="list-style-type: none"> <li>• Recommended spare parts list</li> <li>• E-shop</li> <li>• Interactive spare-parts catalogues</li> <li>• Repairs on electronic parts, glue tanks and electro-spindles</li> </ul>	 <p><b>DIGITAL SERVICES</b></p> <ul style="list-style-type: none"> <li>• Maestro Connect - IoT platform to be constantly connected with your machines</li> <li>• Smartech - assistance with augmented reality</li> <li>• My Scm portal - opening of service ticket and single point of access to the apps and Services tools</li> </ul>

**CONTACT**

**SCM SERVICE**

via Emilia 77 - 47921 Rimini - Italy  
 tel. +39 0541 700100  
 scmsservice@scmgroup.com  
 www.scmwood.com

**SCM SPAREPARTS**

Via Casale, 450 - 47826 - Villa Verucchio (RN) - Italy  
 tel. +39 0541 674111  
 spareparts@scmgroup.com  
 www.scmwood.com



# THE STRONGEST WOOD TECHNOLOGIES ARE IN OUR DNA

## SCM. A HERITAGE OF SKILLS IN A UNIQUE BRAND

70 years of success gives SCM the centre stage in woodworking technology. This heritage results from bringing together the best know-how in machining and systems for wood-based manufacturing. SCM is present all over the world, brought to you by the widest distribution network in the industry.

**70** years history

**3** main production sites in Italy

**300.000** square metres of production space

**20.000** machines manufactured per year

**90%** export

**20** foreign branches

**400** agents and dealers

**500** support technicians

**500** registered patents

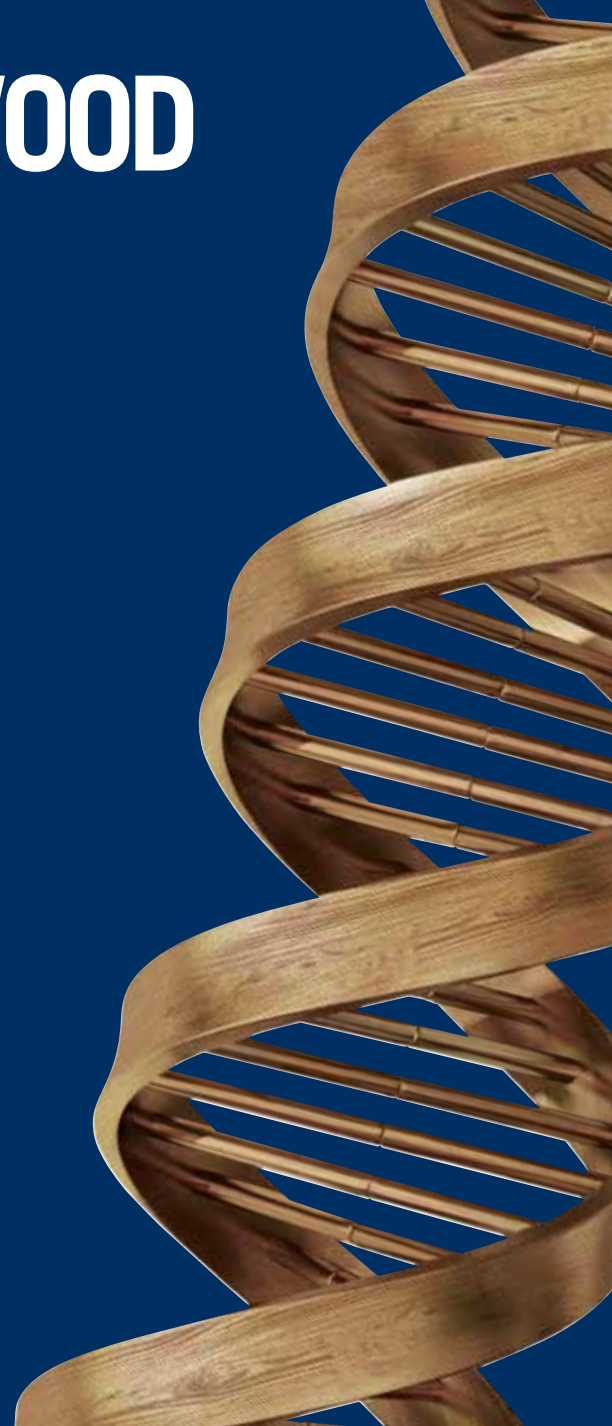

In SCM's DNA also strength and solidity of a great Group. The SCM Group is a world leader, manufacturing industrial equipment and components for machining the widest range of materials.

## SCM GROUP, A HIGHLY SKILLED TEAM EXPERT IN INDUSTRIAL MACHINES AND COMPONENTS

### INDUSTRIAL MACHINERY

Stand-alone machines, integrated systems and services dedicated to processing a wide range of materials.



WOODWORKING TECHNOLOGIES



TECHNOLOGIES FOR PROCESSING  
COMPOSITE MATERIALS, ALUMINIUM,  
PLASTIC, GLASS, STONE, METAL

### INDUSTRIAL COMPONENTS

Technological components for the Group's machines and systems, for those of third-parties and the machinery industry.



SPINDLES AND  
TECHNOLOGICAL  
COMPONENTS



ELECTRIC PANELS



METALWORK



CAST IRON



**SCM GROUP SPA**

via Casale 450 - 47826 Villa Verucchio, Rimini - Italy  
tel. +39 0541 674111 - fax +39 0541 674274  
scm@scmgroup.com  
www.scmwood.com



00L0613220H